

SPATA: Spatio-Tangible Tools for Fabrication-Aware Design

Christian Weichel Jason Alexander Abhijit Karnik Hans Gellersen

Lancaster University
Lancaster, United Kingdom
{c.weichel, j.alexander, a.karnik, h.gellersen}@lancaster.ac.uk

ABSTRACT

The physical tools used when designing new objects for digital fabrication are mature, yet disconnected from their virtual accompaniments. SPATA is the digital adaptation of two spatial measurement tools, that explores their closer integration into virtual design environments. We adapt two of the traditional measurement tools: calipers and protractors. Both tools can measure, transfer, and present size and angle. Their close integration into different design environments makes tasks more fluid and convenient. We describe the tools' design, a prototype implementation, integration into different environments, and application scenarios validating the concept.

ACM Classification Keywords

H.5.2. Information Interfaces and Presentation: User Interfaces - Input devices and strategies

INTRODUCTION

Digital fabrication, such as 3D printing and laser-cutting, enables users to quickly create physical artifacts from digital files. The interfaces and environments used for designing these artifacts are typically tied to a computer screen and are thus removed from the physical world. This separates the physical nature of the fabricated artifacts, and the virtual environments in which they are designed. However, during the design of a fabricable artifact, physical features (i.e., size and angle) play an important role. The artifact will be subject to that physicality once fabricated. Further, fabricated artifacts often interact with previously existing objects e.g., to hold, encase or decorate them.

In this paper we introduce two spatio-tangible tools for fabrication-aware design (SPATA tools), a digital adaptation of two commonly used measurement tools: calipers for measuring length, and bevel protractors for measuring angle. The SPATA tools can measure their respective value (length or angle), but are also actuated so that they can actively present it in the physical world: the calipers have a self-actuated lower jaw that can physically represent length; the protractor can move its blade to output an angle (Figure 1, red parts).

Our tools can bidirectionally transfer—input and output—their value between the physical and virtual world. Users can

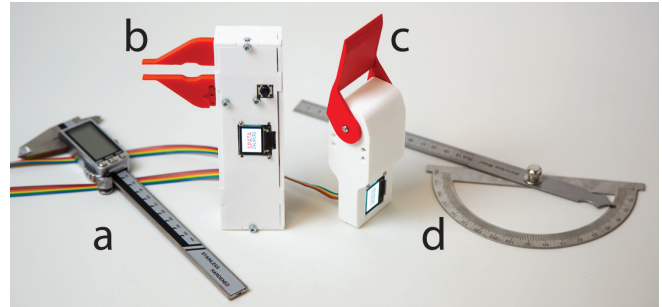

Figure 1. The two SPATA tools next to their original counterparts. (a, b) calipers for size in-/output, (c, d) the protractor for angle in-/output.

measure a physical object, and the measured value is automatically transferred to the design environment. Conversely, length, distance, and angle measured in the virtual environment are automatically transferred to the physical world and presented by the SPATA tools. For example, to get an impression of the size of an object a user is designing, one can measure it in the design environment and have the SPATA calipers tangibly output that size in physical space.

SPATA integrates closely into virtual environments used to design fabricable artifacts, namely mechanical computer aided design (mCAD), mesh-based modeling, and 2D design. When designing new objects in these environments, we create shapes (e.g., primitives like boxes, cylinders or rectangles), manipulate them, and combine them into new forms. Those tasks, in a fabrication-aware context, often require physical measurements taken from existing objects. To reduce the need to switch between the virtual and physical world, we support those tasks in the respective design environments. By partially offloading control to the measurement tools, we can make task execution more fluid and convenient. For example, to model a box-shaped object (e.g., an enclosure) using SPATA, users can measure all three dimensions (width, height, and depth) in sequence without having to put down the SPATA calipers or manually type in measurements.

To further support the design tasks, our tools can sense their orientation, display additional information (such as estimated fabrication time or the amount of required material) and have a button built-in. We combine these capabilities to provide a more integrated and convenient design experience when designing for the physical world. In total, we make the following three contributions:

1. We present digital adaptations of calipers and bevel protractors, that can bidirectionally transfer information be-

Permission to make digital or hard copies of all or part of this work for personal or classroom use is granted without fee provided that copies are not made or distributed for profit or commercial advantage and that copies bear this notice and the full citation on the first page. Copyrights for components of this work owned by others than ACM must be honored. Abstracting with credit is permitted. To copy otherwise, or republish, to post on servers or to redistribute to lists, requires prior specific permission and/or a fee. Request permissions from Permissions@acm.org.

TEI '15, January 16 – 19 2015, Stanford, CA, USA
Copyright © 2015 ACM 978-1-4503-3305-4/15/01\$15.00 .
<http://dx.doi.org/10.1145/2677199.2680576>

tween the physical and virtual world, providing an active tangible interface supplementing fabrication aware design.

2. The integration of both tools into three design environments commonly used for fabrication-aware design: mechanical computer aided design, mesh-based modeling and 2D design (e.g., laser-cutting or circuit board design).
3. Lastly, we demonstrate both tools and their integration in three application scenarios that highlight the benefits of the bi-directional information transfer and design-environment specific task support.

RELATED WORK

SPATA is related to digital fabrication interfaces, active tangibles and spatio-tangible design tools.

Digital Fabrication Interfaces

Interactive fabrication combines the design of an artifact with its fabrication, both situated in the physical world. Willis et al. [24] present a set of example interfaces where fabrication and design blend into one activity, always driven by physical input (e.g., movement or sound). Modelcraft proposes an iterative design process where the annotation of a physical model modifies its virtual counterpart [20]. Hybrid Carving starts with a pre-existing model that can be modified while the user physically carves it out of a block of foam [25], promoting a stronger physical engagement with the artifact. Rivers et al. promote a similar idea for large-scale objects [16]. These interfaces emphasize the physical tools that are used to design and fabricate objects. Inspired by this emphasis, we connect virtual design environments closer to physical tools.

Other systems situate the design process (instead of fabrication) in the physical world to enable the seamless integration of physical features. CopyCAD is centered around the modification of existing 2D outlines [4] projected into a 2D computer-controlled milling machine. Interactive Construction [11] extends this approach to 2D outlines and textures using a laser-cutter as drafting table. MixFab is a mixed-reality environment that enables users to integrate 3D shapes from physical objects into the design process [22]. SPATA is similar to these systems, as it also promotes the integration of existing physical artifacts into fabrication-aware design.

Physical features have also been integrated into entirely virtual fabrication-aware design environments. SketchChair uses a mannequin as size reference for the chair being designed [17]. Enclosed [21], a system to design prototype enclosures, relies on existing models of the components that are being enclosed to provide a spatial reference. Both systems assume that measurements have already been taken. SPATA integrates measuring physical objects into virtual design environments through active, tangible measurement tools.

Active Tangibles

Bi-directional physical interaction through active tangible user interfaces has been used for design tasks. The Actuated Workbench [15] is a top-projected surface on which passive, but magnetic pucks can move autonomously. Used for example to decide cell-phone tower locations, the system always

maintains consistency between the projected and physical state. ZeroN [9] shows an active tangible suspended in mid-air. The commercially available Phantom Chess [3] game uses autonomous tangible chess pieces to interact with the user in two dimensions. Nowacka et al. [13] give an overview of self-actuated autonomous tangible user interfaces. The SPATA tools build on those ideas, as they can autonomously maintain a consistent state of the virtual model and its measurement in the physical world.

Spatio-Tangible Design Tools

A variety of tangible tools for spatial input have been developed. Sheng et al. [19] present a tangible proxy for sculpting 3D models, and ShapeTape [6] enables the direct, tangible control of shape and position in a virtual environment. Other tools focus on specific measurements e.g., HandSCAPE [10] is a digital measurement tape that can transfer its measurements to interior design applications. The commercially available Mitutoyo USB calipers [1] simulate keyboard input whenever their value changes. SPATA builds on this automated transfer, extends it to be bidirectional (from virtual to physical) and generalizes their integration.

Tangible tools have also been used in an augmented reality setting. Lau et al. enable users to create 3D shapes in their designated environment using tangible primitives [8]. ToolDevice [2] introduces tweezers, a knife and a hammer for 3D modeling. With Spatial Sketch [23], users can create 3D shapes in an embodied drawing environment. Schkolne et al. combine the users hand curvature with physical tools to create a tangible, spatially situated design environment [18]. These tools focus on the creation of shapes through tangible and embodied interaction, SPATA focuses on length and angle of 3D models, thus supplements these approaches.

Using props to navigate in 3D space has been explored early on. Hinckley et al. use a rubber ball for neurosurgeons to navigate a 3D model of the brain before surgery [7]. They did not use a realistic prop as a rubber ball can be more comfortably held. Rotating the physical prop directly rotates the model on the screen. The Cubic Mouse [5] also lets users change the models orientation using a spatially tracked prop, but adds a button for clutching. This way, the model can be rotated to any position while the prop can still be held comfortably. Both SPATA tools are spatially tracked and can serve as prop to change the view orientation. We use the button built into the tools for clutching.

SPATA TOOLS

SPATA tools are intended to become part of existing design environments. When designing new objects, designers often need to transfer a measurement into the virtual environment or visualize another measurement to help make a design decision. We go beyond the trivial step of digital acquisition of measurements and transfer to the virtual environment. Our tools provide a higher level of context-awareness to the steps of the design tasks and become integral to their progression. The specific features of the tools are:

- **Measuring and presenting physical values:** SPATA can measure length and angle, as well as present those values

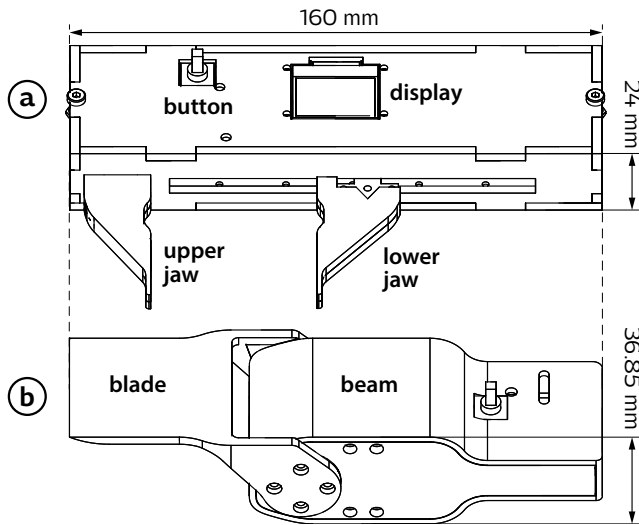

Figure 2. (a) The SPATA calipers and (b) the protractor design. Both have a fixed and actuated part, a five-way button and a display (for (b) the display is on the other side, see Figure 1).

in physical space. As both tools are actuated and computer-controlled, they can tangibly output physical dimensions.

- **Bidirectional value transfer:** Both tools automatically transfer a measurement from the virtual world to the design environment, or the opposite way. Users do not have to manually enter measured values or manually move the jaw/blade (see Figure 2) of the SPATA tools.
- **Design task integration:** We support design tasks by using transferred values in context (e.g., as correct dimension when modeling a box), and by partially offloading task control to the tools. Through the built-in display, five-way button and orientation sensing, users can navigate task steps, select modes and navigate in the 3D world.

In design practice, many different tools are used for measurements. Which tool is used depends on the type of measurement (e.g., size vs. angle) and the order of magnitude at which the measurement is taken (e.g., millimeters vs. meters). Large-scale measurements, for example using a measurement tape, have been integrated into their respective tasks [10]. Small-scale measurements, as they are typically required for personal fabrication, have yet to be integrated.

We identified tools which are important in a personal fabrication setting, through a short questionnaire among 26 personal fabrication practitioners (experience in months: $M = 29.27$, $SD = 33.98$). The results of the survey indicate that for size input, calipers are the most prominently used tool (22 out of 26 practitioners). This potentially relates to the scale of objects targeted by fabrication processes, as well as the precision afforded by the calipers. The only angular measurement tool mentioned was the protractor (4 out of 26 practitioners).

SPATA Calipers

Calipers measure length, diameter and depth. We designed the SPATA calipers to resemble their analog counterpart (Figure 1, c-d). Their size of $160 \times 43 \times 24$ mm approximates the bounding box of traditional calipers. The jaws are shaped to

support the measurement of length and inner diameter (using the thin front of the jaws, see Figure 2, a). As with the original, the upper jaw is fixed and the lower jaw can be moved from 0 mm to 100 mm; either manually or computer actuated.

Our calipers are designed so that they can be held in one hand, with the display and button being easily accessible (Figure 2, a). The display is centered and recessed into the top, giving it a prominent and easily visible position. The button can be operated with the right thumb while holding the tool, particularly when holding it with a single hand (see Figure 4).

We implemented the calipers using audio sliders as actuators. Positional feedback is provided through a voltage divider relative to the sliders position. We drive the audio slider using a dual H-bridge, controlled through a custom PID controller implemented on the microcontroller. The positioning error is less than 1.5 mm – the measurement error is less than 0.5 mm. The enclosure is made from laser-cut acrylic.

SPATA Protractor

Protractors measure the angle between two lines or surfaces. They are often used to explore or measure the slant of a surface. Bevel protractors, a common kind of protractors in mechanical design applications, consist of a beam and a blade. The beam is fixed, the blade can rotate around the center point where both intersect. We stay true to the beam and blade mechanism, with the latter attached to a servo motor (Figure 2, b). Both surfaces are co-planar in their default position (0 deg), and can assume angles from -90 deg to 170 deg.

The SPATA protractor is based on a Dynamixel AX-12A servo motor, which provides a serial interface and reports its orientation with 10 bit resolution. We can sense and actuate the angle with an error of less than one degree. A 3D printed enclosure provides the blade of the bevel protractor design, and encapsulates the electronics, including the servo motor.

Common Hardware

Both tools, calipers and protractor, are based on the same hardware platform. An ATmega328p microcontroller controls the actuator and display. It also captures the button input and accelerometer values. The latter come from an ADXL335 accelerometer that is centered on a custom circuit board. A 4D Systems μ OLED-96-G2 module is used as display. Our tools connect to a communication board that supplies 5V and 9V, and provides a USB/serial interface through an FTDI based USB-serial bridge. Both tools send their measurements and orientation at a rate of 10 Hz.

Client-side Integration

We integrate the tools and the design environments using a custom middleware layer. This middleware contains the communication with the tools, the access to the design environments, and the workflow logic. Both tools are free of integration specific logic, and do not require reprogramming to be used in different environments. The same is true for the design environments, none of them contains any workflow logic; all logic is contained in the middleware layer.

We implemented the integration for three different software packages which are used by digital fabrication practitioners.

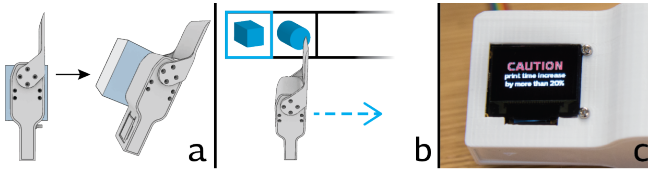

Figure 3. (a) Rotating the SPATA tool to the perspective of the model on the screen. (b) Flicking the tool to the side changes the mode of operation. (c) SPATA tools showing fabrication related information.

To integrate into Autodesk Inventor, representing mechanical CAD, we used the API that comes with the software. Blender, which represents mesh-based modeling, can be scripted with Python. Hooking into the redrawing routine of Blender, we can read commands from a file/Unix pipe and execute them in the modeling environment, thus creating our own remote control API. Because Adobe Illustrator does not provide any extension mechanisms, we simulate key-strokes and analyze screenshots to control this environment.

DESIGN ENVIRONMENT INTEGRATION

Automating the value in- and output from the physical world to the virtual design environment removes the need for manual value transfer. Existing projects and products, such as the *Miutoyo USB calipers* [1], provide automated value input, but are not integrated with the design environments (other than simulating keyboard input). SPATA integrates into design environments, aiming to reduce the required context switches and to make the design process more convenient.

We integrate the SPATA tools into three types of commonly used design environments. Starting from a general 3D environment integration, we specialize to specific environments: mechanical computer aided design (mCAD) and mesh based 3D modeling. The former is often used for product design, the latter for more artistic, organic modeling of shapes. Lastly, we describe how our tools integrate with 2D design environments, for example laser-cutting or circuit board design.

3D Design Environments

We implemented SPATA tools support for two 3D design environments: mechanical CAD and mesh-based modeling. Both environments have common tasks e.g., navigation and tool selection which do not directly affect the 3D shape.

Navigation

Viewing a model from different angles, zooming in and out, as well as panning the model are essential tasks during design. SPATA supports such operations by serving as tangible proxy.

By making SPATA tools tangible proxies for the object being designed, users can change the model orientation by physically changing the orientation of the SPATA tool. This allows users to view and inspect a model from different angles (Figure 3, a). Both tools can represent a continuous variable i.e., the current zoom level. When in zoom mode, users can zoom in and out by moving the lower jaw of the calipers or changing the angle of the protractor blade respectively.

Tool Selection

While designing we need to navigate the design environments user interface to start some operation, change a value or select

a tool. Often times, we need to alternate between two tools e.g., measuring or manipulating a length. Such selection tasks can be performed using quick mid-air gestures: flicking the tools to either side. Users could flick through a color swatch by quickly moving to the left or right (Figure 3, b). Manipulation/measurement modes could be changed by quickly moving forward or backwards.

Second Display

Design decisions often depend on their influence on fabrication: its impact on printing time, material cost or whether support structures are needed. This information can be displayed on the second screen of the SPATA tools. For example, when slanting a surface of a 3D model that is going to be 3D printed, beyond some slope support material is needed. Presenting this information enables users to make an informed decision whether they want to cross that threshold or not (i.e., make the angle 40 degrees instead of 45; see Figure 3, c).

Mechanical CAD

Mechanical computer aided design (mCAD) is used by engineers and designers for product design and prototyping. Mechanical CAD revolves around shapes typically found in man-made objects, such as cylinders, blocks and curves.

Modern mCAD systems e.g., Autodesk Inventor or SolidWorks, are based on 2D sketches which are extruded or revolved into solid 3D objects. When drawing sketches or creating these objects, users need to constrain different dimensions, often using physical values, such as length and angle.

Quick Primitive Creation

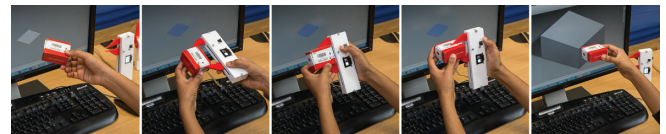

Figure 4. Creating a box (from left to right): select the ground plane, measure width, height and depth.

SPATA supports the creation of boxes from a prescribed series of real-world measurements (e.g., width, height, depth; see Figure 4). The measurements can be performed in rapid succession using the button on the SPATA tool, thus users can create a new cube with no context switch. A similar sequence exists for cylinders: first measuring the diameter, then height. After a primitive has been created, SPATA stays in this mode enabling a series of primitives to be built on top of each other – the *broken sprocket* use-case demonstrates this feature.

Extrusion, Revolution and Holes

More complex shapes can be created by extruding or revolving more drawings. The height of the extrusion, or angle of revolution are often determined by existing physical artifacts, or by the liking of the designer; both of which are best determined in the physical world. Further, mechanical CAD systems often support semantic actions, such as creating holes. We support those tasks by providing a continuous value input: if the value of the tool changes, it's directly used as the respective design parameter (e.g., extrusion height).

This mode is particularly useful if one wants to create a hole with respect to a physical artifact. For example, if a user in a previous step measured a box, and now wants to create a hole in it, they could use the physical box in conjunction with the SPATA calipers to determine the depth of the hole.

Selection

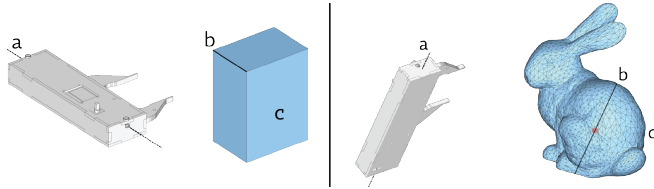

Figure 5. (left) Feature based selection. The axis of the SPATA tool (a) is aligned with a feature (b) of the virtual object (c), causing this feature (i.e., edge) to be selected. (right) Ray-based selection. The axis of the SPATA tool (a) is fixed at a pivot point inside the model (c) and rotated around it (b). The intersection points of this selection ray select vertices.

Each SPATA tool can sense its orientation in space. When a SPATA tool is aligned with a feature e.g., an edge, hole or plane in case of the protractor, that feature is selected (see Figure 5). Once the selection mode has been enabled, the selection is updated continuously until it's confirmed using the button on the SPATA tools. Often times selection is part of another task, in which case the selection is transferred to overarching task e.g., scaling the just selected edge.

Measuring the Model

To measure the length of a feature e.g., the length of an edge or diameter of a hole, the user first selects that feature, either using the SPATA based selection mechanism or using the design environments native one. Once selected, the calipers transfer the length into the physical world. A similar process is used for measuring an angle: after the user selects two planes either using SPATA or the environments native methods, the protractor transfers that value into the real world.

Mesh-based Modeling

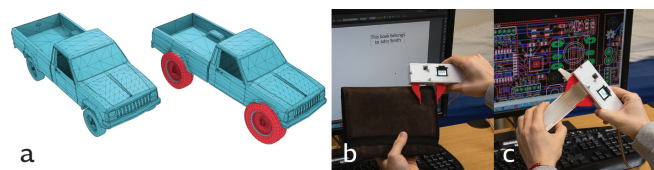

Figure 6. *Local scaling:* (a) Deforming a mesh by scaling only the selected red parts. *2D design:* (b) Placing text on a physical artifact. (c) Ensuring a PCB fit's inside an existing enclosure.

Mesh-based 3D modeling is a general-purpose modeling paradigm, that is often used for creating organic and artistic models in tools such as Autodesk Mudbox, Blender or ZBrush. The smallest unit of manipulation is a vertex or an edge of the 3D model. Modeling operations typically manipulate either a single vertex or a vertex group. Mesh-based modeling often deals with many vertices at the same time: e.g., the Stanford Bunny in Figure 5 has 35947 vertices.

To create new models, designers often start with geometric primitives which are then combined, subdivided and scaled. Vertices are often directly manipulated to form the desired

shape. Additionally to directly manipulating vertices, designers use tools like brushes and stamps to refine the shape. All these operations act on generic vertices and do not carry semantic information (as compared to mechanical CAD).

Selection

We use the accelerometer of the SPATA tools for selection. By rotating a line around a fixed anchor point users can select vertices or vertex groups. This selection line by default extends to one side only, but can also extend in both opposite directions to select orthogonal pairs. The anchor point of the selection line can be moved by the user (see Figure 5).

Depending on subsequent actions, the selection can be continuous so that every orientation change, modifies the selection. In this mode, we can use this selection method like a brush to create vertex groups. It can also be a one-off selection, where the selection is confirmed using the built-in button.

Scaling

We support global and local scaling. Global scaling is applied to the whole model, local scaling is applied to a specific selection of vertices or vertex groups. Scaling the whole model can be used to bring the model to a certain size based on a single dimension. Scaling a selection of vertices is often used to modify the shape locally and to articulate features of the model (see Figure 6, left). For local scaling we support a *select and scale* task, where users first select what they want to scale (using the previously described selection technique) and then perform the modification.

Measuring the Model

To measure length in the design environment, we select two vertices, or planes using the selection mechanism described earlier. We can also use built-in measurement tools (e.g., the ruler/protractor feature in Blender). To measure angle, we select two planes: two model faces, or a global plane and a model face; again using the previously described mechanism or environment specific selection techniques. In both cases the respective tool will output the value in the physical world, as well as on its display.

2D Design

2D design environments are used in many domains, such as for laser-cutting, desktop publishing (DTP) and electronic computer-aided design (eCAD). The often domain-specific design environments revolve around semantic objects such as circles, holes, text blocks and electronic components; objects that need to be arranged and scaled on a 2D canvas.

Translating, Scaling and Rotating

Most 2D design environments have a global coordinate system that spans the working area. Objects placed in the working area have an anchor-point in the coordinate system which is used as point of reference for transformations. Some design environments support snapping mechanisms with regards to that anchor point e.g., snapping to multiples of 5 mm when translating, or 45 degrees when rotating. SPATA supports such snapping mechanisms in form of tactile feedback – for example, the calipers physically snap to the underlying grid.

Translation is used to place objects in the working area; e.g., text on an existing object (see Figure 6, b). SPATA calipers can be used to place objects. Users first select the axis along which they want to place the object; this makes the calipers output the current location into the physical world. Second, any change of the calipers measurement is continuously applied as translation value along that axis, synchronously moving the object (with respect to the anchor point). Scaling is performed in the same way. After selecting the axis, the calipers output the current value and update the size with every change of measurement. During object placement, it may be necessary to rotate an object. Entering rotation mode, causes the protractor to output the current orientation into the physical world. Changing that angle with immediately update the objects rotation around the anchor point.

Measuring the Design

We implement a feature-based measurement strategy, as most two-dimensional artifacts have semantic annotations (e.g., parts placed on a PCB or a rectangle drawn on a poster). Users first select the features they want to measure using the design environments built-in selection mechanism, which is typically mouse-based. When a single feature is selected (e.g., the outline of a printed circuit board, see Figure 6, c) the length of that feature is transferred into the physical world. When two features are selected at the same time, and they have an angle of inclination to one-another, we output that angle using the protractor.

APPLICATION SCENARIOS

We illustrate the integration of the SPATA tools into the three design environments. By walking through examples for each environment, we demonstrate the tools capabilities and how they make the design process more convenient.

Replacing a Broken Sprocket

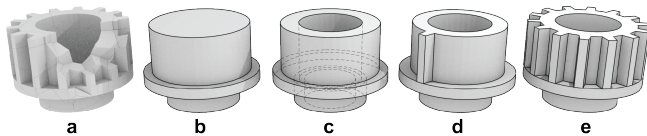

Figure 7. Replacing a broken part. (a) the broken sprocket we want to replace, (b - d) the intermediary steps for modeling the replacement part, (e) the finished part.

In this example scenario we're going to model a working replica of a broken sprocket (see Figure 7, a) in a mechanical CAD environment. Repairing broken parts with digital fabrication requires the creation of a printable model. Because the part is physically broken, we need to complete it while modeling it. In this case, 3D scanning the part is not feasible, as we require an exact geometrical representation of the object in order to complete/repair it.

As with many man-made objects, the sprocket consists of geometric primitives, primarily cylinders. We start modeling by introducing a series of cylinders (Figure 7, b). For each cylinder we first measure its diameter, then the height, confirming each value with the built-in button. In this *cylinder mode*, SPATA builds one cylinder on top of another, resulting in a configuration depicted in Figure 7, b.

Next, we add the two inner holes. We again use the *cylinder mode*, only this time we instruct the design environment to cut out the cylinders, instead of adding them. Measuring first the diameter, then height of each of the two holes, yields our second intermediary model shown in Figure 7, c.

In order to add the gear teeth, we first create a single tooth which is then replicated around the gear. Each tooth is a regular cube. Specifying its width, height and depth fully describes the shape (see Figure 7, d). We count the number of teeth and assume a uniform distribution of teeth around the gear. Adding the according number of teeth, creates the final replacement part (Figure 7, e).

Modeling the replacement sprocket required a total of 12 sizes to be measured of the physical object. Using analog calipers, we need to not only manually type in all measurements, but also change repeatedly change context to do so (23 times if one measures the height of the sprocket teeth in CAD). The SPATA tools automatically transfer the measurements, and support creating the primitives that make up the sprocket. This way, we have to refocus our attention fewer times (6 times) and can perform the task more efficiently.

Sculpting

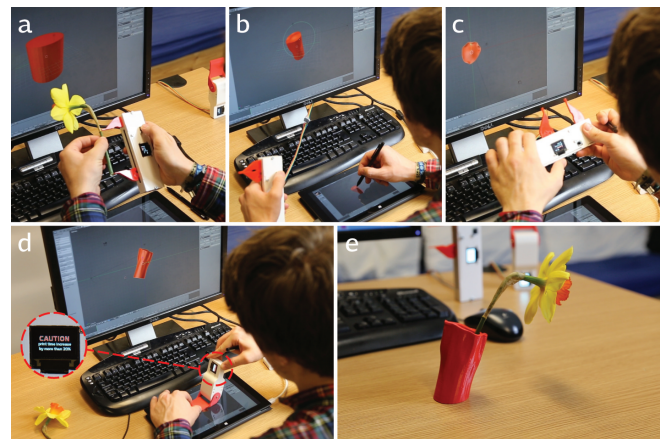

Figure 8. Creating a vase. (a) We start with a cylinder, scaled to eight centimeters using the SPATA calipers. (b) We sculpt decorative features, using the SPATA tools for orientation. (c) Checking the size of the model. (d) Exploring different flower hole angles, resulting in a print time warning. (e) The printed result object.

In this scenario we want to create a flower vase which will be 3D printed. To model that vase, we use a mesh-based design environment that supports vertex-based modeling, sculpting and constructive solid geometry. For artistic modeling often pen input is used instead of a mouse; we follow this practice.

We start the design process by creating a new cylinder. The vase needs to be correctly sized so that flowers fit in it and that it can be placed on a desk. Using the SPATA calipers and their ability to globally scale, we scale the cylinder until it is eight centimeters high. Using local scaling, we scale the diameter of the vase to 4 centimeters (see Figure 8, a).

Next, we add the decorative features by drawing on the cylinder using the pen. We use the SPATA calipers, which we now hold in our non-dominant hand, to rotate the model so that we

can draw on all sides (see Figure 8, b). This way we do not have to change the mode from drawing to rotating, but use the pen to draw, the SPATA tool to rotate.

Sculpting the shape has changed its size as well. Using Blender's built in measurement tool, we measure the vase model. This causes the SPATA calipers to output that size in the physical world (see Figure 8, c). This way we can compare the size against the flower, or get a feeling for the dimensions of the vase we are creating.

To make the vase more interesting, we want it to stand slightly angled. To explore different angles, we use the SPATA protractor. During this exploration our focus is on the SPATA tool, which gives us additional, fabrication specific feedback. When we use a too steep angle, we'll be warned when the current angle will make the fabrication take longer and be more expensive (see Figure 8, d).

Lastly, we cut off the bottom to create a flat surface for the vase to stand on and add the flower hole. We then send it to a 3D printer. The resulting vase fits the flower as designed and does not need support structures to print (see Figure 8, e).

Desktop Organizer

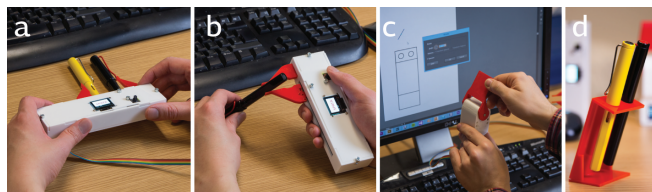

Figure 9. (a) Measuring the width of the pen holder using the pens it will hold. (b) Measuring the pen holder's height. (c) The drawing used for laser-cutting the parts of the holder. (d) The final object.

This scenario demonstrates SPATA's integration into a 2D design environment, as they are often used for laser-cutting. We create a simple, laser-cut pen holder.

We start by creating the top face of the pen holder. After starting to draw a rectangle, we use the SPATA calipers to measure its width and height (see Figure 9, a). The button on SPATA tools can be used to confirm and navigate between measurement axis (width and height). Next, we create the back piece. Its width is determined by the width of the top panel, but the height is measured using SPATA. After selecting height as dimension we wish to scale, every new measurement is immediately set as new height. In this mode, we measure the height of the pen. Then we create circular cutouts much like we created the first rectangle: measuring the diameter of the pen yields holes of correct size (see Figure 9, b).

We use the protractor to explore which angle we want the pen holder to be at. After enabling rotation, the protractor assumes the current orientation: zero degrees in this case. Manipulating the protractor's blade rotates the line on the screen accordingly (see Figure 9, c). Pressing the built-in button confirms the rotation. To fabricate the object, we laser-cut this drawing and assemble the pieces by acrylic-welding them. This yields our final object (Figure 9, d).

DISCUSSION

Generalizing To Other Tools

The SPATA concept, automated measurement transfer and integration into design environments, generalizes to tools other than calipers and protractors. On different scales, different tools are used. HandSCAPE [10], the digital measurement tape for example, could also output its value using an additional motor. Alternatively, a folding ruler could be augmented to support input and output of not only length, but also angle along its joints.

Physical features besides length and angle could also be considered. For example, an integrated measurement tool for material stiffness could be used to design multi-material 3D printed objects. Techniques such as jamSheets [14] could serve as output technology. Similarly, tools for transferring elasticity or weight and volume could be built (e.g., using technology presented by Niiyama et al. [12]).

Implementing the Integration

While building the tools, we implemented their integration into Autodesk Inventor, Blender and Adobe Illustrator. We found it beneficial to contain all logic in an integration middleware layer. Many software packages support an API to extend their functionality (e.g., SketchUp has a Ruby based plugin mechanism). We further kept both SPATA tools free of design environment specific artifacts, to avoid firmware changes. When developing other tools based on the SPATA concept, we recommend a similar approach to enable quick prototyping and exploration.

Customization

We have implemented tasks commonly found in their respective environments (e.g., creating a box in mechanical CAD). However, specialists often customize their environments to better support their work. A macro editor (or other forms of end-user programming) would enable users to create their own workflows or tasks that integrate the SPATA tools. Custom jaws and blades for specific applications could also be built. For example using specialized task support and adapted tools that align well with human physique, doctors could quickly model a splint for their patient.

Applicability

SPATA is tightly integrated into digital design environments, thus their use is primarily beneficial in a digital design process. When measuring things in an analog setting, traditional tools are preferable over our prototype implementation. In their current iteration SPATA tools are tethered to a computer, restricting the environments they can be used in. Additionally, in their current iteration, the tools are not as precise as their analog counterparts. This prevents them from being used to very small parts. Further, traditional calipers have a thin depth probe to measure the depth of cavities and holes. The current implementation of SPATA calipers does not have such a depth probe, rendering depth measurements difficult.

Non-Fabrication Scenarios

The need for integrating spatial features extends beyond design for fabrication. In computer supported collaborative

work (CSCW), or whenever there is a spatial/temporal division between users, SPATA could be used to transfer spatial features. For example, two spatially disconnected users could exchange the screen-size of the new tablet they've bought. In a temporally disconnected scenario, users could get an impression of the size of an object offered in an online store, or measure parts of their body to order a custom-made artifact.

CONCLUSION

In this paper we presented spatio-tangible measurement tools that aim to make the design of fabricable artifacts more efficient and convenient. By automating the measurement transfer between the tools and design environments, we make the process less error prone; by integrating the tools into the tasks found in these environments, we make the process more efficient and convenient. To demonstrate how the design process can benefit from our tools, we use our prototype implementation to walk through three application scenarios.

In future work, we plan to study how the SPATA tools benefit digital fabrication practitioners; particularly if the number of context switches can be reduced in daily practice (similar to the first application scenario).

ACKNOWLEDGMENTS

This work was supported by the EU Marie Curie Network iCareNet under grant number 264738.

REFERENCES

1. Mitutoyo corporation:
<http://www.mitutoyo.co.jp/eng/index.html>.
2. Arisandi, R., Takami, Y., Otsuki, M., Kimura, A., Shibata, F., and Tamura, H. Enjoying virtual handcrafting with tooldevice. In *Adjunct Proc. UIST* (2012), 17–18.
3. Excalibur Electronics, Inc. *Phantom Force - Auto-Motion Intelligent Response Chess*. Excalibur Electronics, Inc., Excalibur Electronics, Inc., 13755 SW 119th Av, Miami, Florida 33186 U.S.A.
4. Follmer, S., Carr, D., Lovell, E., and Ishii, H. Copycad: remixing physical objects with copy and paste from the real world. In *Proc. UIST* (2010), 381–382.
5. Fröhlich, B., and Plate, J. The cubic mouse: A new device for three-dimensional input. In *Proc. CHI* (2000), 526–531.
6. Grossman, T., Balakrishnan, R., and Singh, K. An interface for creating and manipulating curves using a high degree-of-freedom curve input device. In *Proc. CHI* (2003), 185–192.
7. Hinckley, K., Pausch, R., Goble, J. C., and Kassell, N. F. Passive real-world interface props for neurosurgical visualization. In *Proc. CHI* (1994), 452–458.
8. Lau, M., Hirose, M., Ohgawara, A., Mitani, J., and Igarashi, T. Situated modeling: a shape-stamping interface with tangible primitives. In *Proc. TEI* (2012), 275–282.
9. Lee, J., Post, R., and Ishii, H. Zeron: mid-air tangible interaction enabled by computer controlled magnetic levitation. In *Proc. UIST* (2011), 327–336.
10. Lee, J., Su, V., Ren, S., and Ishii, H. Handscape: A vectorizing tape measure for on-site measuring applications. In *Proc. CHI* (2000).
11. Mueller, S., Lopes, P., and Baudisch, P. Interactive construction: interactive fabrication of functional mechanical devices. In *Proc. UIST* (2012), 599–606.
12. Niiyama, R., Yao, L., and Ishii, H. Weight and volume changing device with liquid metal transfer. In *Proc. TEI* (2014), 49–52.
13. Nowacka, D., and Kirk, D. Tangible autonomous interfaces (tais): Exploring autonomous behaviours in tuis. In *Proc. TEI* (2014), 1–8.
14. Ou, J., Yao, L., Tauber, D., Steimle, J., Niiyama, R., and Ishii, H. jamsheets: Thin interfaces with tunable stiffness enabled by layer jamming. In *Proc. TEI* (2014), 65–72.
15. Pangaro, G., Maynes-Aminzade, D., and Ishii, H. The actuated workbench: Computer-controlled actuation in tabletop tangible interfaces. In *Proc. UIST* (2002), 181–190.
16. Rivers, A., Moyer, I. E., and Durand, F. Position-correcting tools for 2d digital fabrication. *ACM Trans. Graph.* 31, 4 (July 2012), 88:1–88:7.
17. Saul, G., Lau, M., Mitani, J., and Igarashi, T. Sketchchair: an all-in-one chair design system for end users. In *Proc. TEI* (2011), 73–80.
18. Schkolne, S., Pruett, M., and Schröder, P. Surface drawing: creating organic 3d shapes with the hand and tangible tools. In *Proc. CHI* (2001), 261–268.
19. Sheng, J., Balakrishnan, R., and Singh, K. An interface for virtual 3d sculpting via physical proxy. In *Proc. GRAPHITE* (2006), 213–220.
20. Song, H., Guimbretière, F., Hu, C., and Lipson, H. Modelcraft: capturing freehand annotations and edits on physical 3d models. In *Proc. UIST* (2006), 13–22.
21. Weichel, C., Lau, M., and Gellersen, H. Enclosed: A component-centric interface for designing prototype enclosures. In *Proc. TEI* (2013).
22. Weichel, C., Lau, M., Kim, D., Villar, N., and Gellersen, H. Mixfab: A mixed-reality environment for personal fabrication. In *Proc. CHI* (2014).
23. Willis, K. D., Lin, J., Mitani, J., and Igarashi, T. Spatial sketch: bridging between movement & fabrication. In *Proc. TEI* (2010), 5–12.
24. Willis, K. D., Xu, C., Wu, K.-J., Levin, G., and Gross, M. D. Interactive fabrication: new interfaces for digital fabrication. In *Proc. TEI* (2011), 69–72.
25. Zoran, A., Shilkrot, R., and Paradiso, J. Human-computer interaction for hybrid carving. In *Proc. UIST* (2013), 433–440.